

CHSN09L120

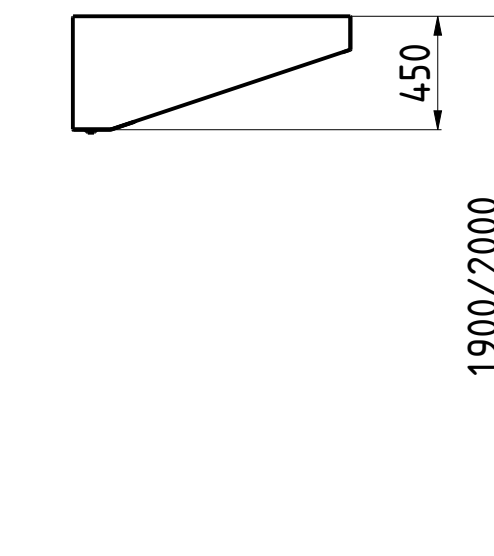

FORO AxB HOLE AxB	E	NR. LUCI NR. LIGHTS	PORTATA FLOW RATE	HST mmH ₂ O	WATT	SDR	PESO (Kg) WEIGHT (Kg)
210x230	230	—	1360	24	147	7/7	56

DATA DATE	MODIF. N. MODIF. NO.	DESCRIZIONE MODIFICHE MODIFICATION DESCRIPTION	DISEGNATO DRAWN BY	APPROVATO APPROVED
MODELLO MODEL		CAPPA SNACK CON MOTORE 9/12 SNACK HOOD WITH MOTOR 9/12	SCALA SCALE	-
PARTICOLARE DETAIL		SCHEDA TECNICA DATA SHEET	DATA DATE	-
MATERIALE MATERIAL		AISI 304 - AISI 430	SPESS. THICK.	-
FINITURA FINISH			PEZZI N. PIECES NO.	
TRATTAMENTO TREATMENT			COLORE COLOUR	
			SHEET	1 OF 2
			ULTIMA EMISS. LAST EDITION	

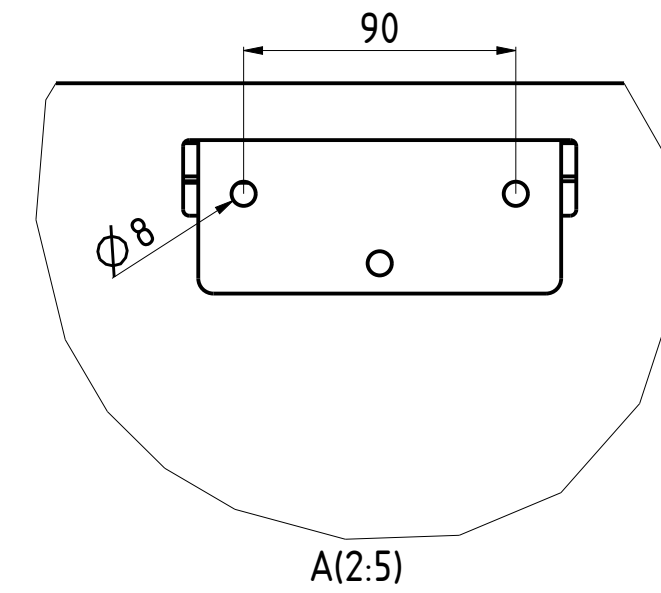
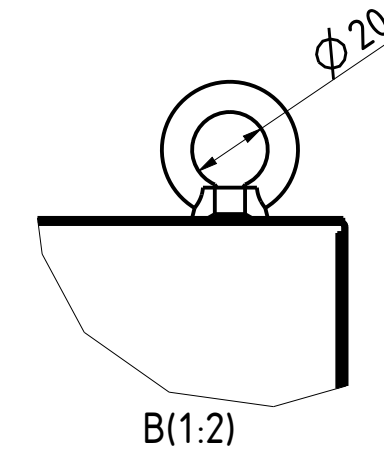
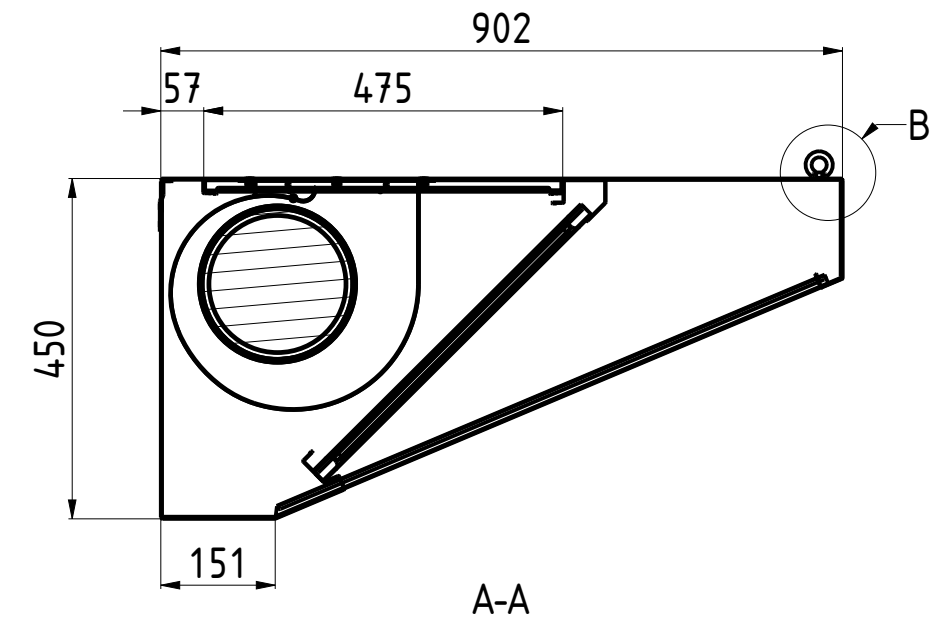
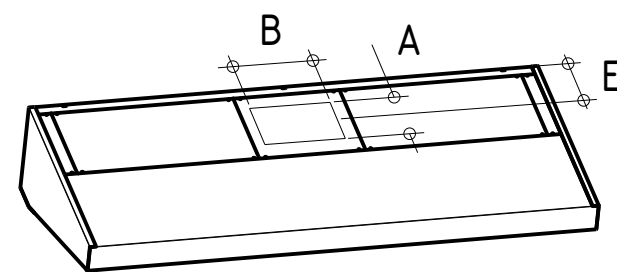
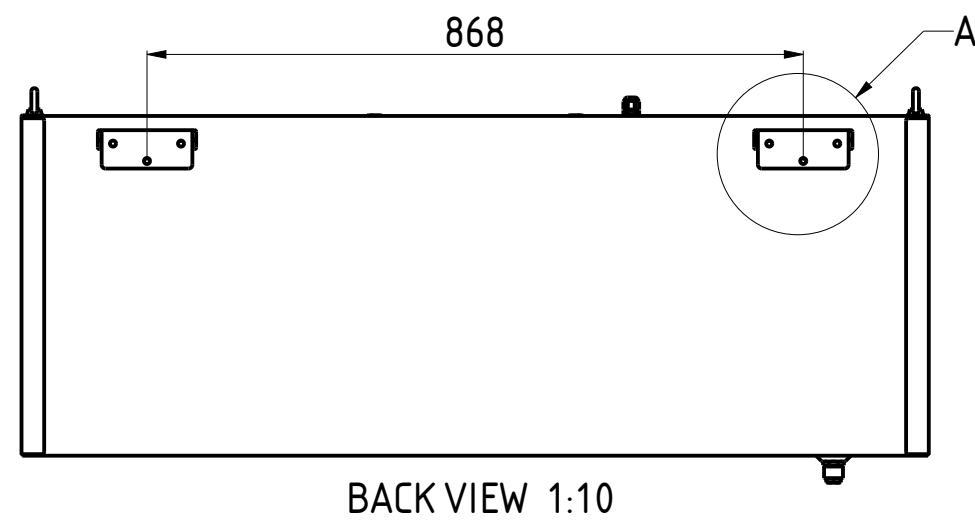
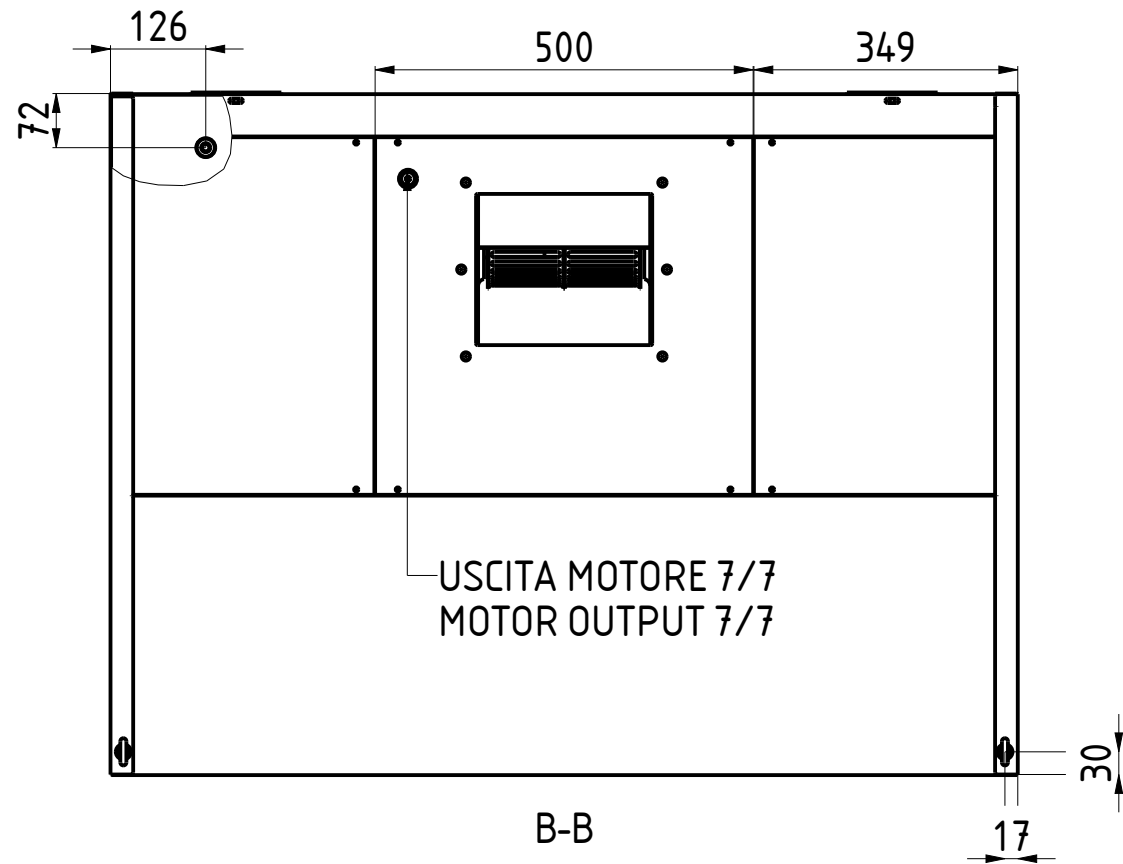
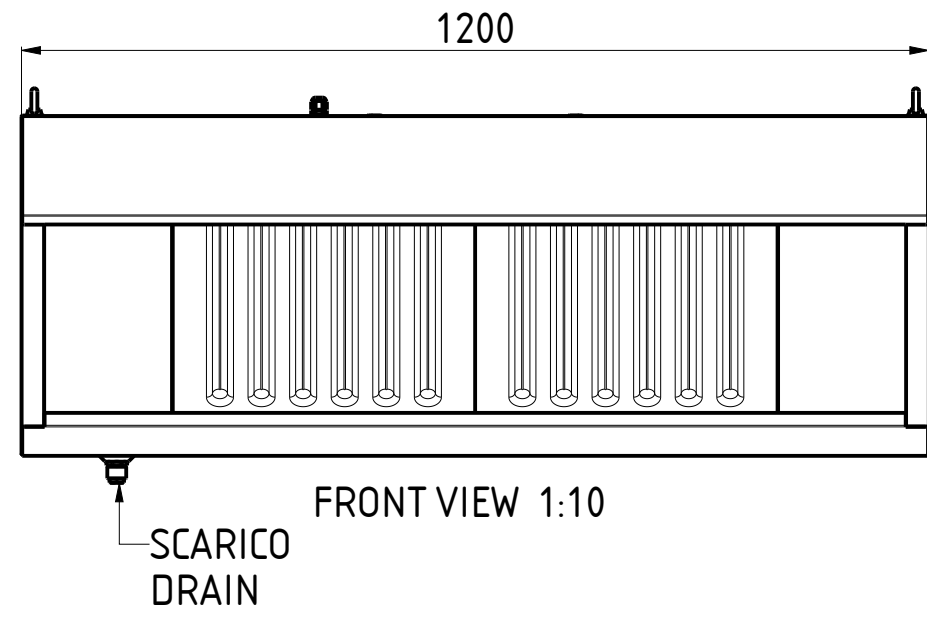
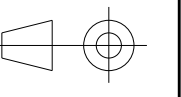

mm

FORM.A-2

TOLLERANCE UNLESS OTHERWISE STATED
 QUOTE SENZA TOLLERANZA
 TOLLERANCE UNLESS OTHERWISE STATED
 QUOTE SENZA TOLLERANZA
 ELABORATO CON SISTEMA CAD
 DESIGNED BY CAD/STEM
 QUOTA PRIMARIA
 PRIMARY DIMENSION
 XX
 ANGOLI
 Angles
 >500
 ±0.75
 400-500
 ±0.65
 315-400
 ±0.60
 250-315
 ±0.55
 180-250
 ±0.50
 120-180
 ±0.45
 80-120
 ±0.40
 50-80
 ±0.35
 18-30
 ±0.25
 10-18
 ±0.20
 5-10
 ±0.15
 0-5
 ±0.10
 LUNGHEZZE E DIAMETRI
 LENGTH AND DIAM.
 ±0.10